



The Habitations Collection

Lounge Chair	p. 3
Tavern Chair	p. 4
Dining Chair	p. 5
Dining Tables	p. 6, 7
Chaise Lounge	p. 8
Bench	p. 9
Serving Cart	p. 10
Mobile Coffee Table	p. 10
Side Table	p. 11
Ottoman	p. 11
Market Umbrella	p. 12
Cushions	p. 13
Meet Our Designer	p. 14
<i>Ordering, Delivery</i>	p. 15



To Order
CALL

Tel 508-497-9591
Fax 508-435-5663

Welcome to Back Habitats

We have combined style with comfort to create first-ever contemporary cedar furniture. Hand sculpted pieces, novel engineering, and ingenious assembly offer a unique experience in buying and enjoying outdoor furnishings.

Back support and comfort result from careful planning. Our attention to posture and proportion make our seats a pleasure to sit in. Our tables are also well conceived. But you need good seating to enjoy any sitting arrangement. That's why comfortable seating is our devoted principle.

Our products use mortise and tenon joinery. Screws are completely recessed out of site. Larger assemblies deploy bolts, which tie into threaded inserts located in the frame. This overall design prevents loose joints and assures a very strong, stable product needed to endure the outdoors.

All furniture is shipped natural, unstained. Some pictures show what can be done with exterior stains. Due to practical advances in staining, options to beautify your investment today by staining are limitless. It is also common to leave cedar natural to watch it turn to a silvery gray with time.

Enjoy browsing our digital catalog.



President



Lounge Chair

37H x 32D x 26W

Enjoy the sensual curves and ultra comfort of this chair. Getting in and out is easy.

The seat portion has a pelvic tilt angled upwards, which eliminates lower back pain.

“S” curves in both the back and seat offer pronounced back support and reduce stress to the buttocks.

Shown: mahogany stain

\$299



Tavern Chair

33H x 24D x 24W

Our Tavern Chair is as comfortable around a dining table as it is solo on a patio or deck. It offers a generous seat and sturdy arms and legs. It's gently rounded back and curved seat allow comfortable long-term sitting.

It is commonly used with our ottoman and creates a friendly grouping with our tables.

Shown: marine oil stain

\$199



Dining Chair

33H x 22D x 20W

Enjoy enhanced comfort in our Dining Chair, featuring slight tilt in seat and posture-forming lumbar support.

Shown: natural without stain

Individually \$180 in set of 4 \$150 ea.

Minus Arms \$160 in set of 4 \$130 ea.



Dining Table

40 x 40 x 30H (seats 4)

A work of art, our tables feature one of kind hand-sculpted, multi-facet legs.

The tabletop has five dowels running through it (shown to top right). Dowels prevent warping and add artistic interest.

Designed to resist the wind, the mass of the table is placed in the legs offering a lower center of gravity. It will not end up in your pool.

Shown: clear polyurethane stain

\$399

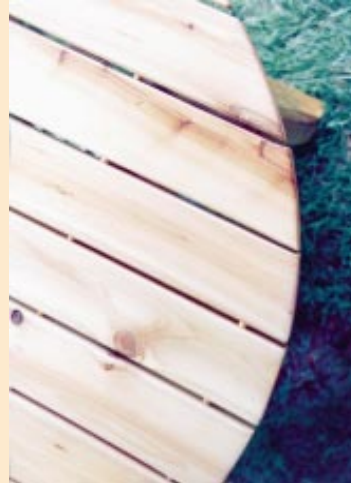

Large Dining Tables

40W x 60L x 30H (seats 6) \$499

40W x 80L x 30H (seats 8) \$599

These larger tables have the same leg design as our 40" version. The tops deploy the same anti-warp, multi dowel design.

The legs are spread farther apart than table seating 4.

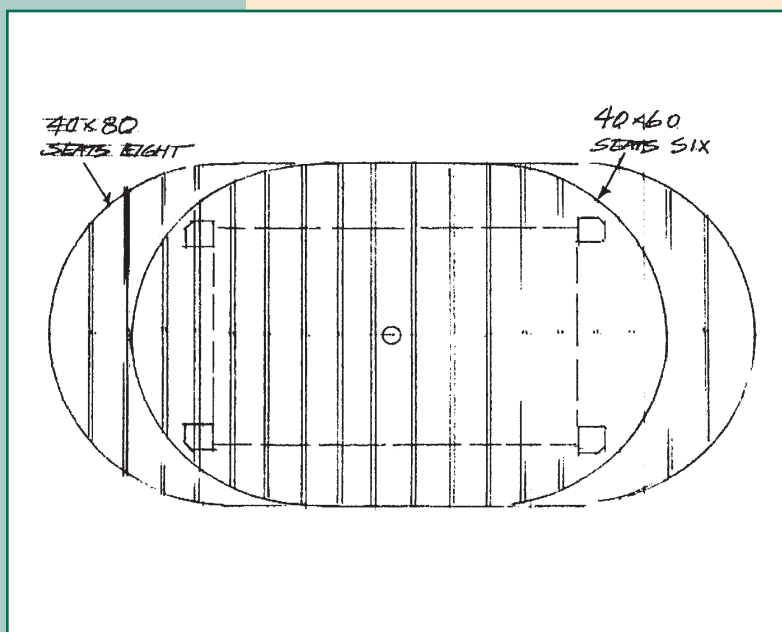

Chaise

78L x 24 x 12.5

The chaise is versatile. It's back moves between 4 positions, and lowers completely flat to allow using the chaise as a bench.

Shown: natural without stain

\$299



Chaise Wheels

Our signature floral designs add exquisite detail to our chaise and other products. Wheels are offered in solid mahogany or aluminum.



4 ft. Bench

47L x 34H x 24W

Our Bench repeats the style and large proportions of our Tavern Chair, elongated to bench size.
Shown: natural without stain

\$249



Coffee Table

20W x 40L x 17H

Our coffee table is a larger version of our side table. Same bowed-top design.
Shown: front view at left, and top view at right.

\$149

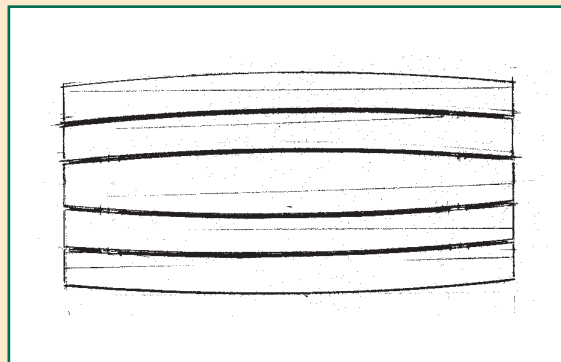
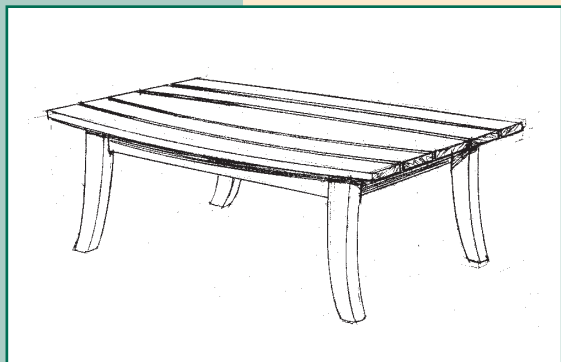

Serving Cart (3-tier)

21W x 40L x 34H

Cart features drop in, tempered glass top, and choice of either aluminum or mahogany wheels shown below, right.

\$399

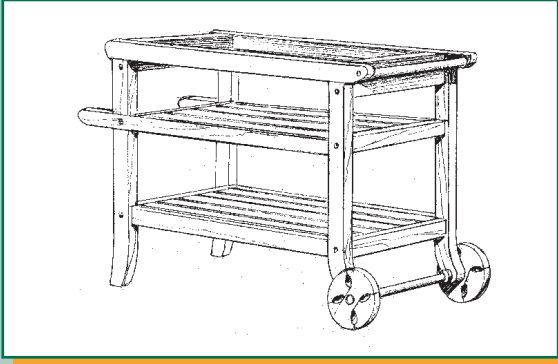

Mobile Coffee Table (2-tier)

24W x 38L x 18H

Table features tempered glass and choice of either aluminum or mahogany wheels.

\$299

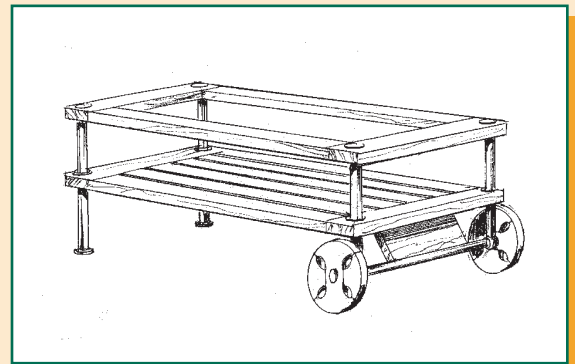

Side Table

20W x 23L x 18H

The table's bowed-top design accents its refined legs and offers ample room for books or food tray.
Shown: Below, front view; Right, side view. Shown: Creme-white solid stain
Ships fully assembled.

\$79



Ottoman

16H x 21L x 21W

Our ottoman is the accessory of choice for the lounge chair.
Its sinuous curves fortify our contemporary collection.
Shown: creme-white solid stain.
Ships fully assembled.

\$89

Market Umbrella

9' Height

Solid wood with brass fittings. It's cotton draws and pulleys are the break-proof alternative to crank types.

Umbrellas fit into all dining tables. Can order to match cushion colors.

Our umbrellas have a vent system at their top. This allows wind to escape to avoid blowing over.

Umbrella

\$229

Solid Aluminum Stand Wt. 30 lbs.

\$79



Prices - Cushions

<i>Tavern chair</i>	<i>\$49</i>
<i>Lounge chair</i>	<i>\$49</i>
<i>Chaise (double length, hinged)</i>	<i>\$99</i>
<i>Bench</i>	<i>\$69</i>
<i>Dining chair</i>	<i>\$29</i>

The addition of cushions affects the dimension of a chair. Cushions subtract either depth of seat or height of back. Due to varied effects on human bodies when using cushions, it is impossible to predict who will like what. We advise buying one cushion initially to find your comfort.

All cushions have medium firmness. They are a full 2" thick. Welting runs around the edge of all cushions, thus protecting against wear on it's edges.

Pictures in this catalog show cushions in forest green. All cushions are made to fit our furniture perfectly.

Fabric Color



Olive Green Floral



Taupe



Navy Blue, White Stripe



Forest Green



Taupe, White Stripe



Navy Blue



Forest Green, White Stripe

Portrait of an Artist

Erve Sabeau is an artist trained in architecture and fine arts. As a sculptor he has worked with wood, metal, and acrylics. He has built boats, which led to patents for steam bending and laminating new forms of contemporary furniture. He has designed over 100 furniture collections for Ethan Allen and Thomasville.

Sabeau's lifelong concern with organic forms derived from nature is realized in "Habitations". This interest creates the Back Habitats style. First-ever contemporary cedar furniture.

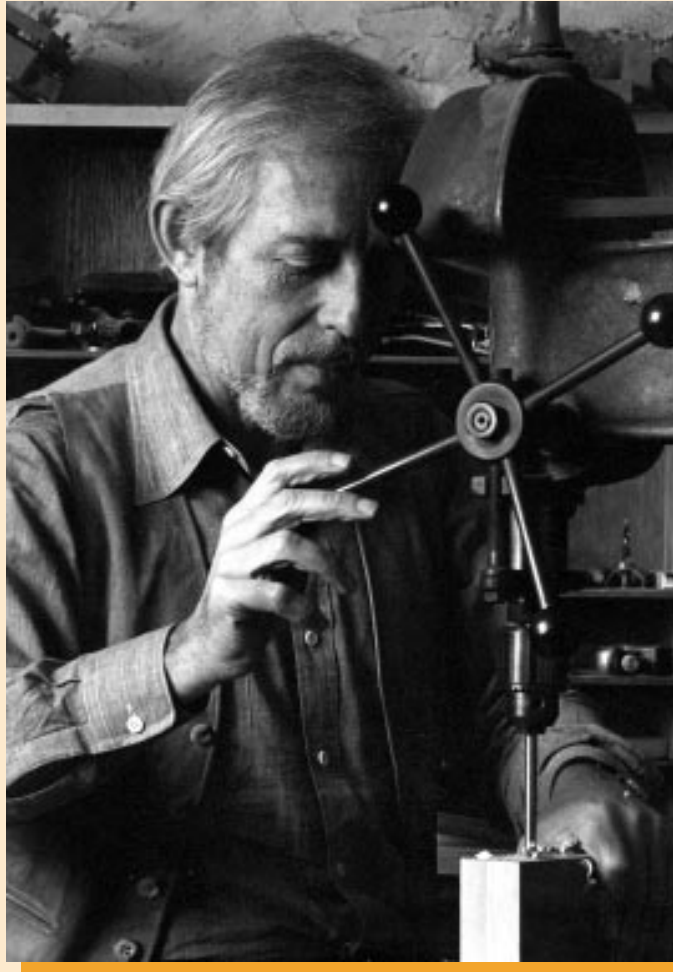

ERVE SABEAU

1998 High Point Pinnacle Award Recipient

Delivery

Orders shipped 2-3 weeks. All pieces are shipped \$9.00 each, except the chaise and dining tables, which ship \$14 each.

Assembling Furniture

Screwdriver-Only Assembly

Our chairs and benches arrive in 4 parts, called sub-assemblies: 2 Arm/legs, seat, and back. These are assembled in 5-10 minutes using only a regular screwdriver or cordless electric screwdriver. 3 bolts for each side of the chair or bench are provided. Merely screw through pre-drilled holes and into threaded inserts in the frames. Just match up the holes. Clear instructions guide you.

All dining tables ship in 3 parts. 2 leg sub-assemblies, and one matching tabletop. Screwdriver only is needed. 5 minutes needed to assemble.

Serving cart and mobile coffee table ship knocked down also. They are both assembled similar to the chairs. 15 minutes required to assemble.

Guarantee

Critical joints (those which connect arms to legs) are mortise & tenoned. We guarantee these critical joints will not loosen or come undone under normal use for a period of 10 years. Should any joints fail, Back Habitats will incur all costs in shipping and replacing parts.

Replacement Parts

Over time should you incur damage, for most of our furniture you need only unscrew bolts and return the sub-assembly that is damaged. And should you ever need to relocate the furniture, easy disassembly creates a smaller package.



To Order
CALL

Tel **508-497-9591**

Fax **508-435-5663**